



Welding Strenx[®] and Hardox[®]

SSAB



Welding of Strenx[®] and Hardox[®]

The extreme performance of Strenx high strength steel and Hardox wear plate is combined with exceptional weldability. Any conventional welding method can be used for welding these steels to any type of weldable steel. This brochure is aimed at simplifying, improving and boosting the efficiency of the welding process. It offers good advice on preheat and interpass temperatures, heat input, welding consumables, shielding gas and a great deal more. The aim is to enable every user to gain full benefit of the unique properties of Strenx and Hardox.

Important parameters in welding

Clean the joint to remove foreign matter such as moisture and oil residue before welding. In addition to good welding hygiene, the following items are important:

- ▶ Preheat and interpass temperature
- ▶ Heat input
- ▶ Welding consumables
- ▶ Shielding gas
- ▶ Weld sequence and gap size in the joint

Preheat and interpass temperatures

The right preheat and interpass temperature is important in order to avoid hydrogen cracking. Our recommendations are given in the table on the next page.

INFLUENCE OF ALLOYING ELEMENTS ON THE CHOICE OF PREHEAT AND INTERPASS TEMPERATURES

A unique combination of alloying elements optimizes the mechanical properties of Strenx and Hardox. This combination governs the preheat and interpass temperature of the steel during welding, and can be used to calculate the carbon equivalent value. The carbon equivalent value is usually expressed as CEV or CET in accordance with the equations below.

The alloying elements are specified in the inspection certificate of the plate and are stated in percent by weight in these formulas. A higher carbon equivalent usually requires a higher preheat and interpass temperature. Typical values of carbon equivalents are given in our product data sheets.

$$CEV = C + \frac{Mn}{6} + \frac{(Mo+Cr+V)}{5} + \frac{(Ni+Cu)}{15} [\%]$$

$$CET = C + \frac{(Mn+Mo)}{10} + \frac{(Cr+Cu)}{20} + \frac{Ni}{40} [\%]$$

HYDROGEN CRACKING

Due to their low carbon equivalents, Strenx and Hardox are better able to resist hydrogen cracking than many other high strength steels. The risk of hydrogen cracking will be minimized if our recommendations are followed.

Two rules for avoiding hydrogen cracking:

1. MINIMIZE THE HYDROGEN CONTENT IN AND AROUND THE PREPARED JOINT

- ▶ Use the right preheat and interpass temperature
- ▶ Use welding consumables with a low hydrogen content
- ▶ Keep impurities out of the weld area

2. MINIMIZE THE STRESSES IN THE WELD JOINT

- ▶ Do not use welding consumables of a higher strength than is necessary
- ▶ Arrange the weld sequence so that the residual stresses are minimized
- ▶ Set the gap in the joint to a maximum of 3 mm

PREHEAT AND INTERPASS TEMPERATURES FOR STRENX AND HARDOX

The lowest preheat and interpass temperature during welding is shown in the chart below. Unless otherwise stated, these values are applicable for welding with unalloyed and low-alloyed welding consumables.

- ▶ When plates of different thicknesses, but of the same steel grade are welded together, the thickest plate determines the required preheat and interpass temperature.
- ▶ When different steel types are welded together, the plate requiring the highest preheat temperature determines the required preheat and interpass temperature.

MINIMUM RECOMMENDED PREHEAT AND INTERPASS TEMPERATURES FOR DIFFERENT SINGLE PLATE THICKNESSES [mm]

	3	10	20	30	40	50	60	70	80	90	120	130
Strenx 700	Room temperature (approx. 20°C)	Room temperature (approx. 20°C)	Room temperature (approx. 20°C)	75°C	75°C	100°C	100°C	100°C	100°C	100°C	100°C	100°C
Strenx 900*	Room temperature (approx. 20°C)	75°C	75°C	100°C	100°C	100°C	100°C	100°C	100°C	100°C	100°C	100°C
Strenx 960*	75°C	75°C	100°C	100°C	100°C	100°C	100°C	100°C	100°C	100°C	100°C	100°C
Strenx 1100*	Room temperature (approx. 20°C)	Room temperature (approx. 20°C)	125°C	125°C	125°C	125°C	125°C	125°C	125°C	125°C	125°C	125°C
Strenx 1300*	100°C	100°C	100°C	100°C	100°C	100°C	100°C	100°C	100°C	100°C	100°C	100°C
Hardox HiTuf	Room temperature (approx. 20°C)	Room temperature (approx. 20°C)	Room temperature (approx. 20°C)	Room temperature (approx. 20°C)	Room temperature (approx. 20°C)	100°C	100°C	125°C	125°C	125°C	125°C	125°C
Hardox 400	Room temperature (approx. 20°C)	Room temperature (approx. 20°C)	75°C	75°C	100°C	100°C	175°C	175°C	175°C	200°C	200°C	200°C
Hardox 450	Room temperature (approx. 20°C)	Room temperature (approx. 20°C)	125°C	125°C	125°C	125°C	150°C	150°C	150°C	150°C	150°C	150°C
Hardox 500	Room temperature (approx. 20°C)	Room temperature (approx. 20°C)	175°C	175°C	175°C	175°C	200°C	200°C	200°C	200°C	200°C	200°C
Hardox 550	Room temperature (approx. 20°C)	Room temperature (approx. 20°C)	175°C	175°C	200°C	200°C	200°C	200°C	200°C	200°C	200°C	200°C
Hardox 600	Room temperature (approx. 20°C)	Room temperature (approx. 20°C)	175°C	175°C	175°C	175°C	175°C	175°C	175°C	175°C	175°C	175°C
Hardox 600 Stainless steel consumables	Room temperature (approx. 20°C)	Room temperature (approx. 20°C)	100°C	100°C	100°C	100°C	100°C	100°C	100°C	100°C	100°C	100°C
Hardox Extreme Stainless steel consumables	Room temperature (approx. 20°C)	Room temperature (approx. 20°C)	100°C	100°C	100°C	100°C	100°C	100°C	100°C	100°C	100°C	100°C

Room temperature (approx. 20°C)
 Outside the size range
 Only stainless steel consumables

Note: The table is applicable to single plate thickness when welding with a heat input of 1.7 kJ/mm.

MAXIMUM RECOMMENDED INTERPASS TEMPERATURE

Strenx 700**	300°C
Strenx 900**	300°C
Strenx 960**	300°C
Strenx 1100	200°C
Strenx 1300	200°C
Hardox HiTuf**	300°C
Hardox 400	225°C
Hardox 450	225°C
Hardox 500	225°C
Hardox 550	225°C
Hardox 600	225°C
Hardox Extreme	100°C

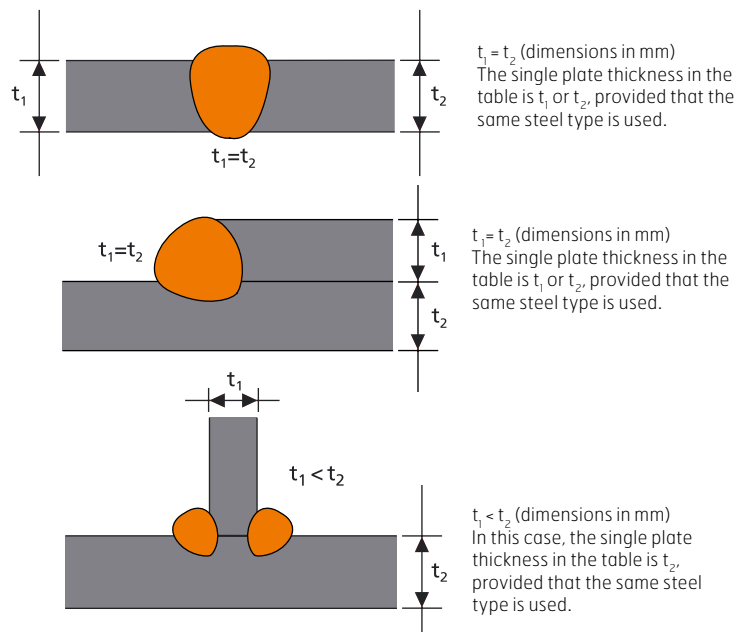

* The consumables determine the preheating temperature if its carbon equivalent is higher than that of the plate.

** Interpass temperatures of up to approx. 400 °C can be used in certain cases for Strenx 700–960 and for Hardox HiTuf. In such cases, use WeldCalc.

If the ambient humidity is high or the temperature is below +5 °C, the lowest recommended preheat temperatures given on the previous page should be increased by 25 °C. This also applies to firmly clamped weld joints and if the heat input is 1.0 kJ/mm.

The lowest recommended preheat and interpass temperatures in the chart on the previous page are not

ATTAINING AND MEASURING THE PREHEAT AND INTERPASS TEMPERATURE

The required preheat and interpass temperature can be achieved in several ways. Electric preheater elements around the prepared joint are often best, since they

affected at heat inputs higher than 1.7 kJ/mm.

The information is based on the assumption that the welded joint is allowed to cool in air.

Note that these recommendations also apply to tack welds and root runs. Each of the tack welds should be at least 50 mm long. The distance between tack welds can be varied as required.

provide uniform heating of the area. The temperature should be monitored by using, for example, a contact thermometer.

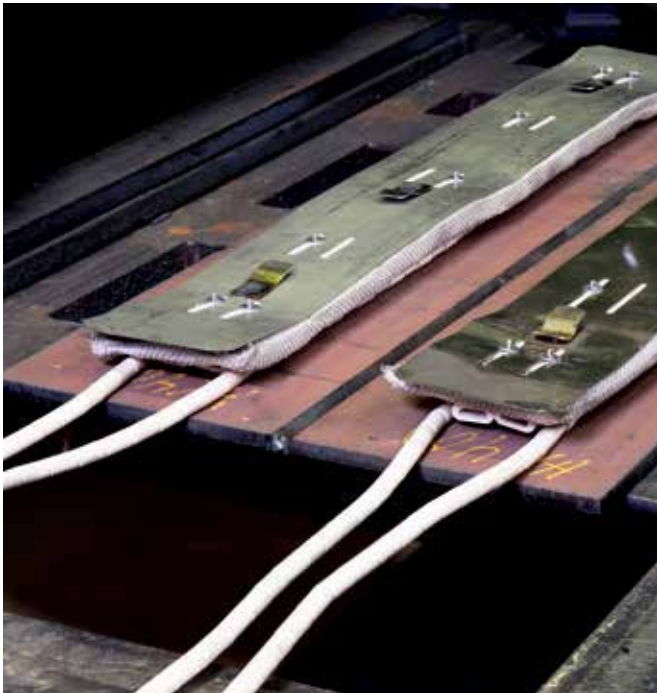

Using preheater elements

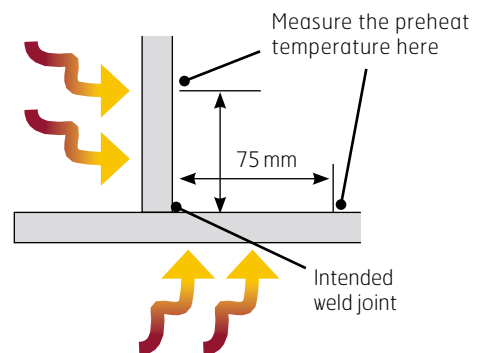

Measure the temperature of the thickest plate in the joint. If the plate is 25 mm thick, measure the temperature 2 minutes after heating. If the plate is 12.5 mm thick, measure the temperature after 1 minute, etc. The interpass temperature can be measured in the weld metal or in the immediately adjacent parent metal.

Heat input

WELDING WITH THE RECOMMENDED HEAT INPUT RESULTS IN GOOD MECHANICAL PROPERTIES IN THE HEAT AFFECTED ZONE (HAZ)

The heat supplied by the welding process affects the mechanical properties of the welded joint. This is described by the heat input (Q) that can be calculated using the formula below.

Different methods of welding have varying thermal efficiency (k). See the table below for approximate values of this property.

$$Q = \frac{k \times U \times I \times 60}{v \times 1000}$$

Q = Heat input [kJ/mm]

U = Voltage [V]

I = Current [A]

v = Welding speed [mm/min]

k = Thermal efficiency [dimensionless]

Thermal efficiency

k [dimensionless]

MMA

0.8

MAG, all types

0.8

SAW

1.0

TIG

0.6

EFFECTS OF HEAT INPUT ON A WELD JOINT

▶ Better toughness

▶ Increased strength

▶ Reduced deformation

▶ Lower residual stresses

▶ Narrower HAZ

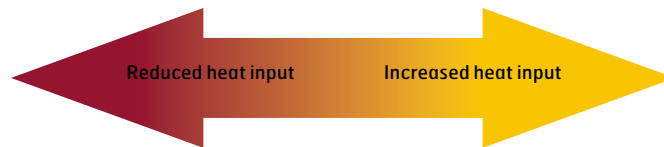

▶ Higher productivity for conventional welding methods

Our recommendations for Strenx high strength steel are based on typical values for toughness in the HAZ being at least 27 J at -40 °C. The demands on toughness in the weld joints in Hardox wear plate are often lower.

The recommendations for Hardox should therefore be regarded as approximate values.

When a joint comprising different plate thicknesses is welded, the recommended heat input is based on the thinnest plate in the welded joint.

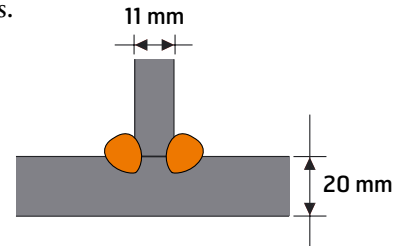

In this case, the permissible heat input is based on the 11 mm plate thickness.

RECOMMENDED MAXIMUM HEAT INPUT FOR STRENX, BASED ON THE LOWEST PREHEAT TEMPERATURE BEING USED:

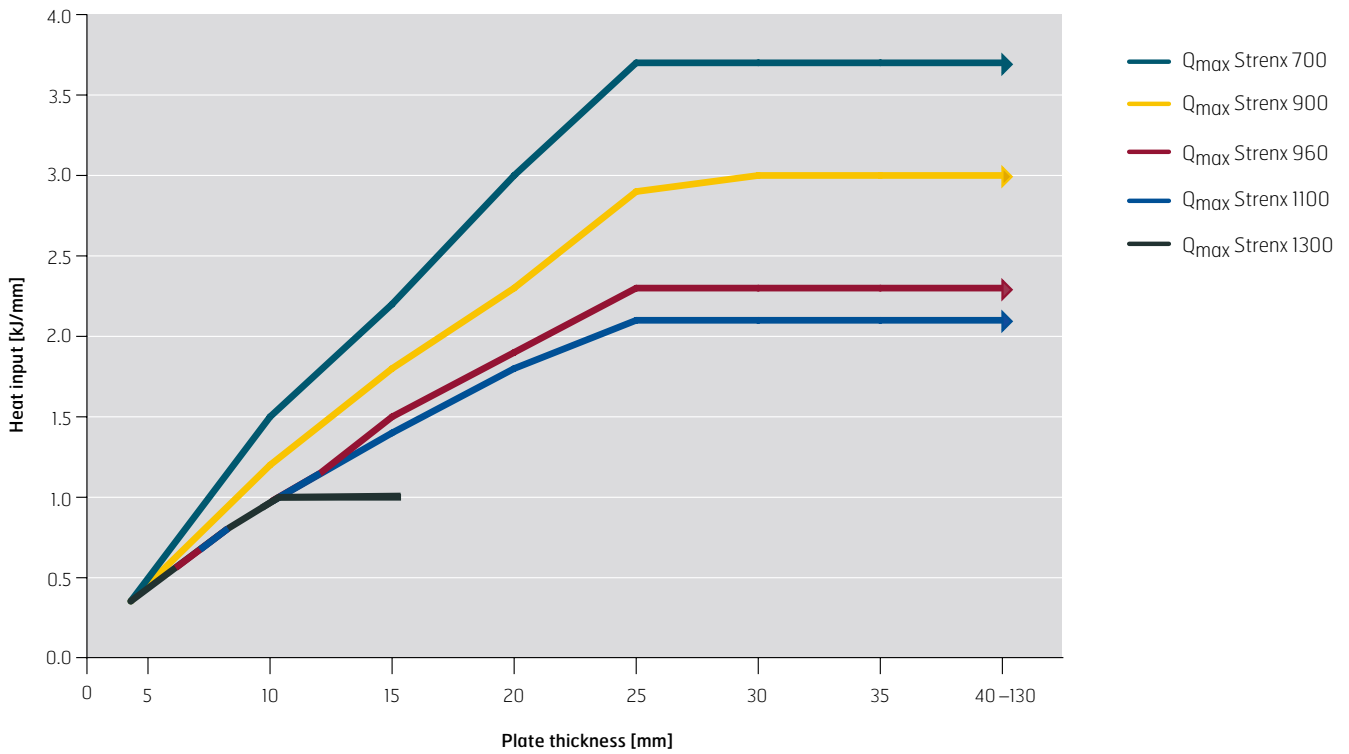

RECOMMENDED MAXIMUM HEAT INPUT FOR HARDOX

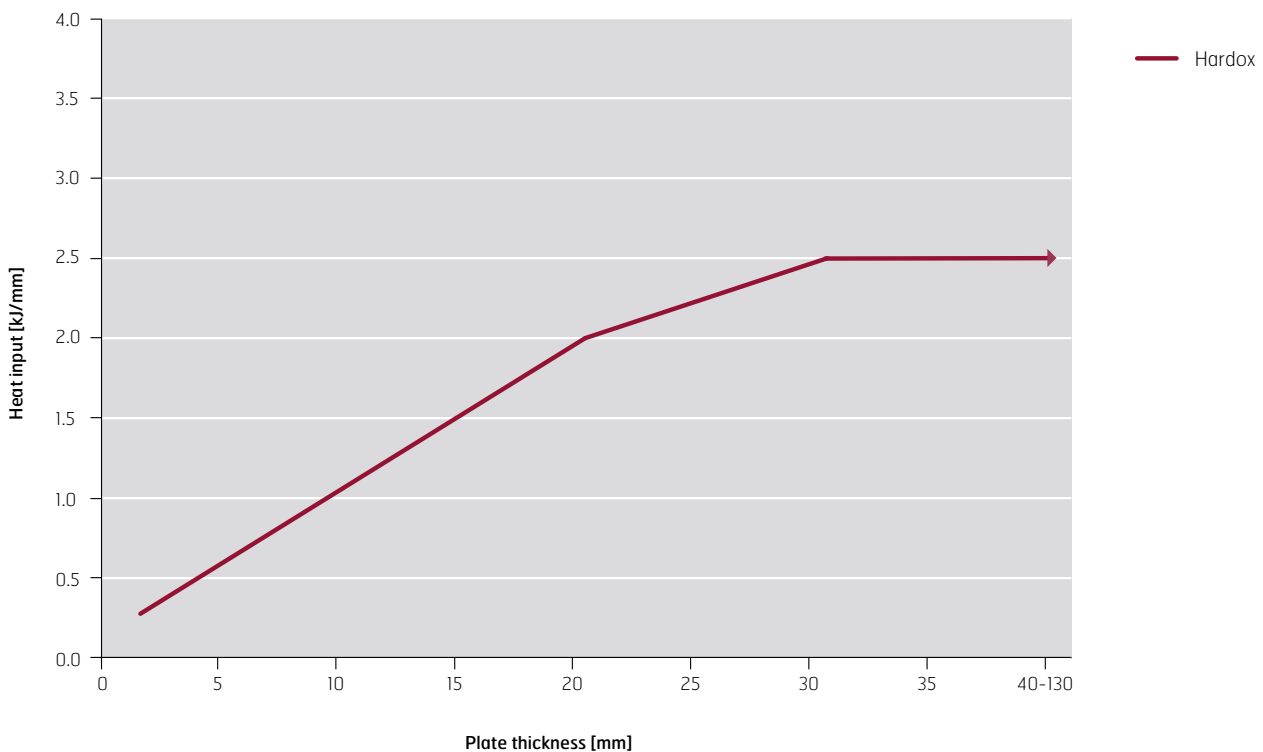

WELDING AT HIGHER ELEVATED TEMPERATURES

Higher elevated temperatures that may occur, for instance in multipass weld joints, affect the recommended heat input. The figure below shows the recommended heat inputs for joint temperatures of 125 °C and 175 °C.

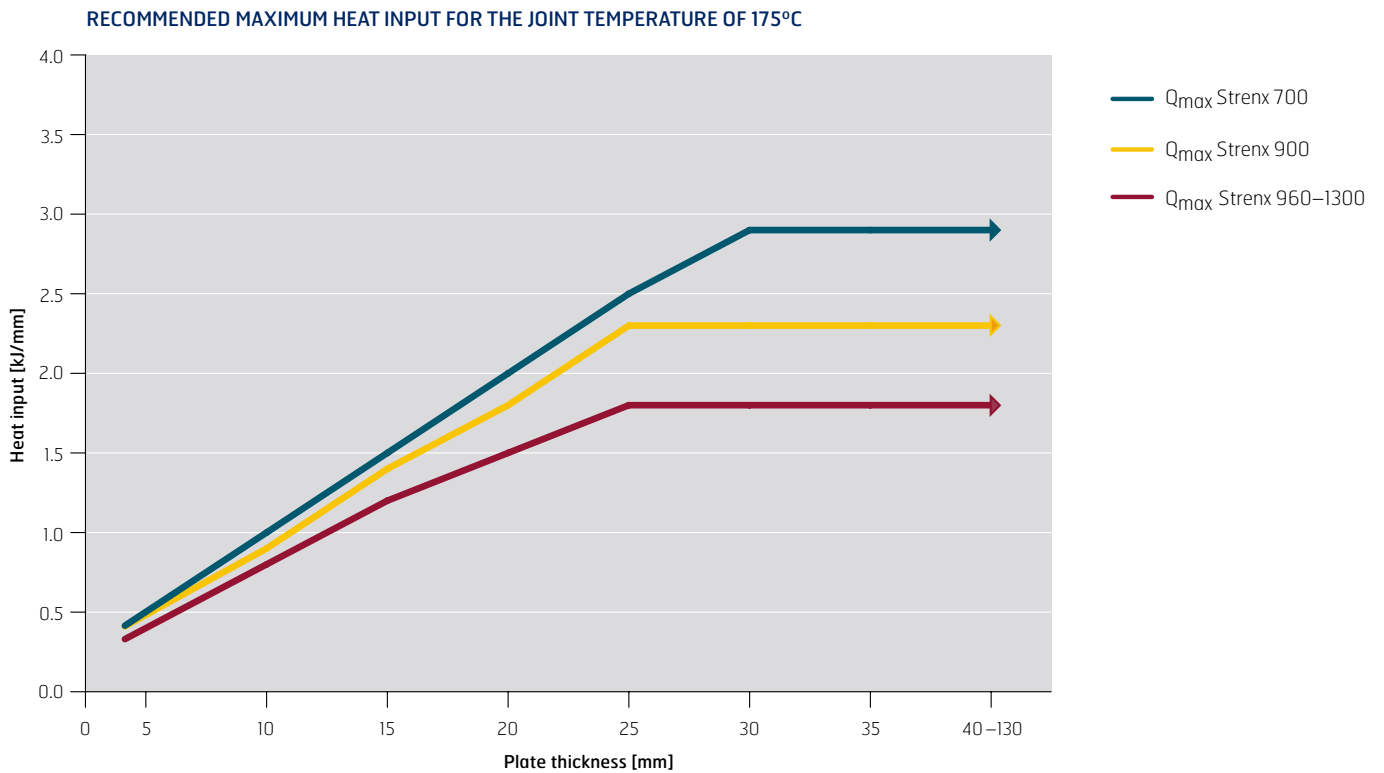
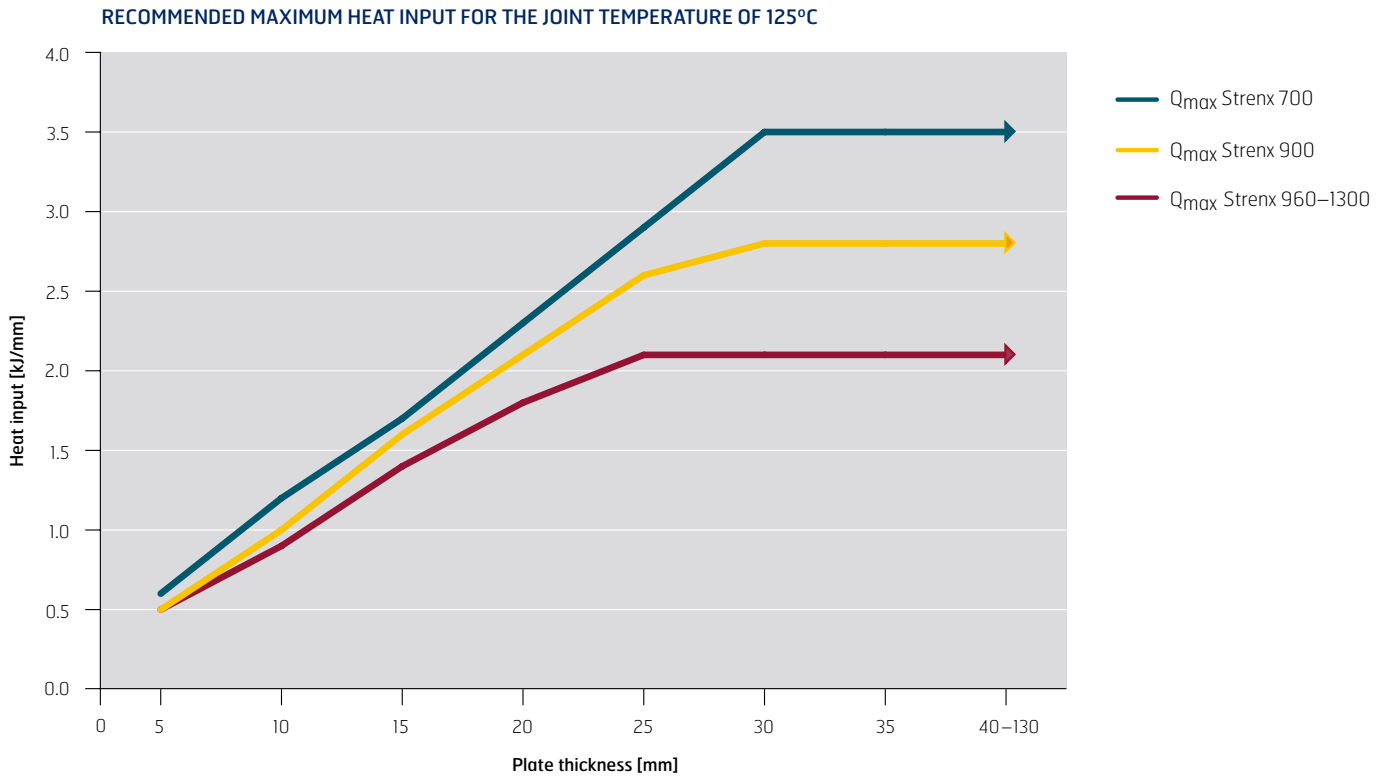

The WeldCalc computer program can be used for preheat and interpass temperatures above 175 °C. WeldCalc has been developed by SSAB by our world leading experts on the welding of heavy plate. The program can be ordered free of charge at www.ssab.com.

Welding consumables

Unalloyed, low-alloyed and stainless steel consumables can be used for the welding of Strenx and Hardox.

STRENGTHS OF UNALLOYED AND LOW-ALLOYED WELDING CONSUMABLES



The strength of the welding consumables should be selected in accordance with the figure on the next page. Using low-strength consumables can offer several benefits, such as higher toughness of the weld metal, higher resistance to hydrogen cracking and lower residual stresses in the weld joint. In multipass joints in Strenx 700–1300, it is particularly beneficial to weld with consumables of different strengths. Tack welds and the first passes are welded with low strength consumables and then high strength consumables are used for the remainder of the passes. This

technique can increase both the toughness and the resistance to hydrogen cracking.

The carbon equivalent value of consumables with a yield strength > 700 MPa may be higher than that of the plates.

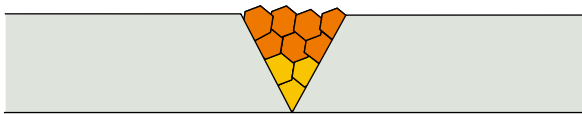
When there are different recommended preheat temperatures for the joint materials and the consumables, then the highest value should be used. Hardox should be welded with low strength consumables as shown in the figure on the following page.



-  Welding consumables with higher strength
-  Welding consumables with lower strength

HYDROGEN CONTENT OF UNALLOYED AND LOW-ALLOYED WELDING CONSUMABLES

The hydrogen content should be lower than or equal to 5 ml of hydrogen per 100 g of weld metal when welding with unalloyed or low-alloyed welding consumables. Solid wires used in MAG and TIG welding can produce these low hydrogen contents in the weld metal. The hydrogen content for other types of welding consumables can best be obtained from the respective manufacturer.

Examples of consumables are given at www.ssab.com in the publication TechSupport #60. If consumables are stored in accordance with the manufacturer's recommendations, the hydrogen content will be maintained at the intended level. This applies, above all, to coated consumables and fluxes.

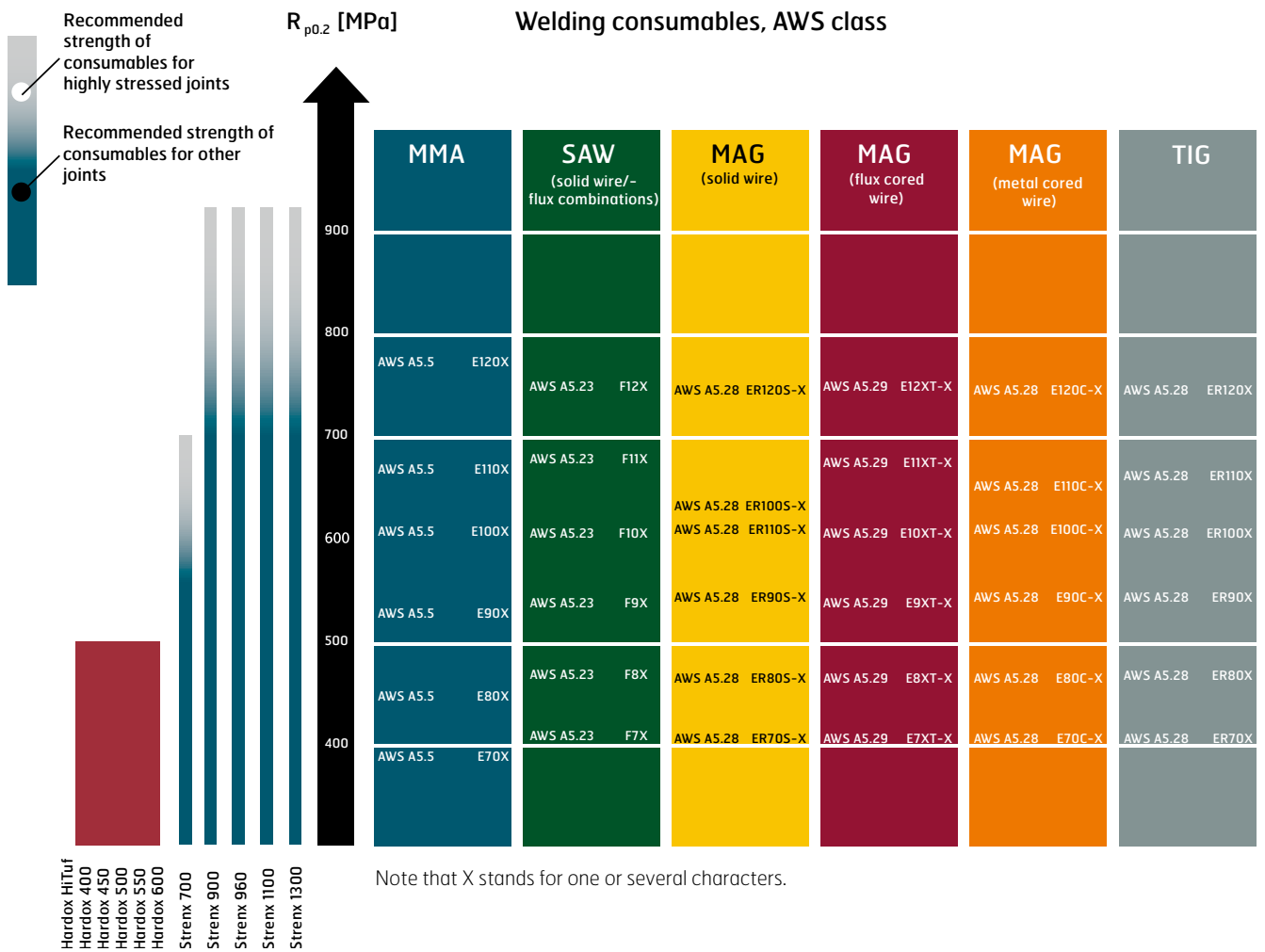
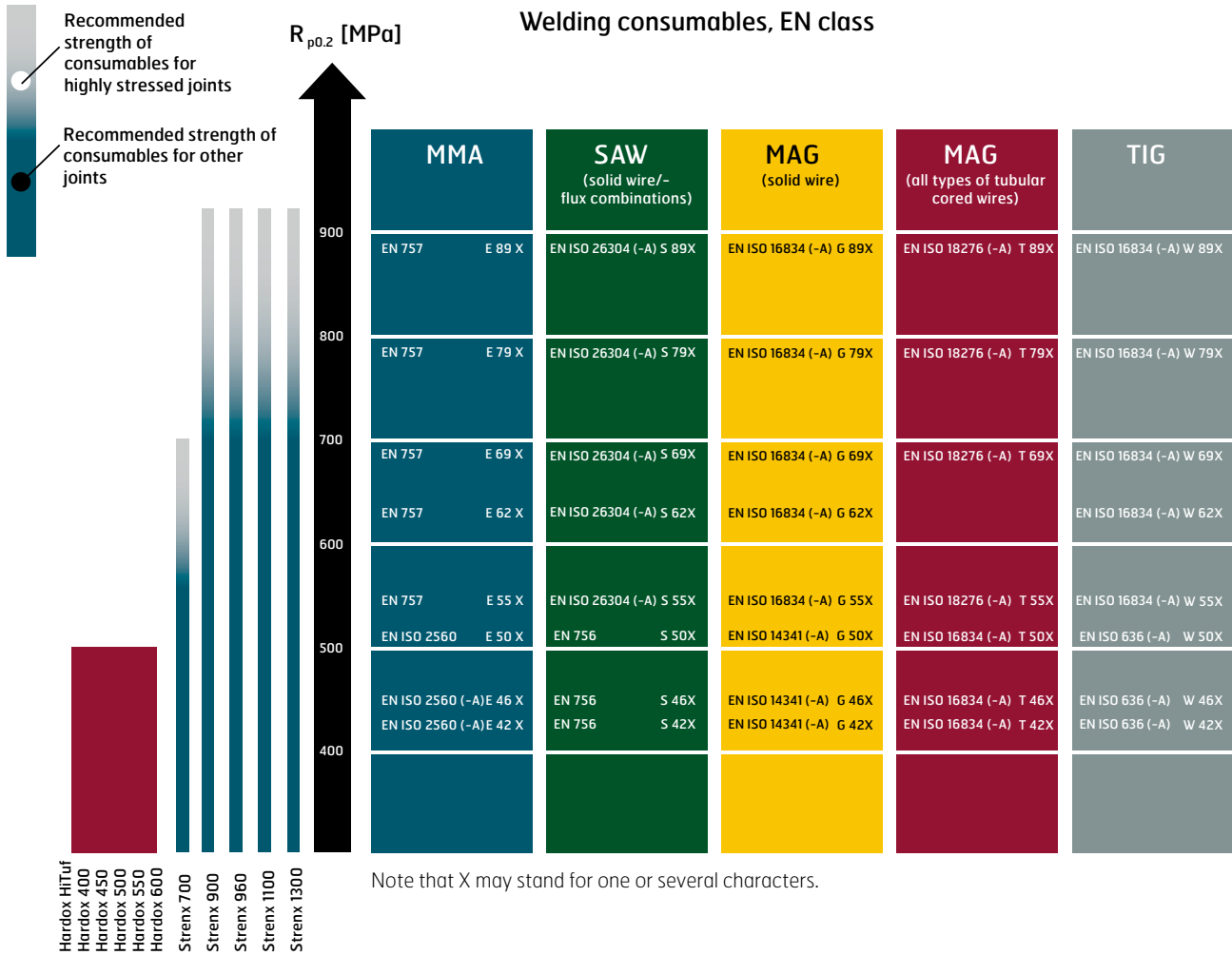

STAINLESS STEEL WELDING CONSUMABLES

Consumables of austenitic stainless steels can be used for the welding of all our products. They allow welding at room temperature (+20 °C) without preheating, excluding Hardox 600, as shown in the chart.

We recommend giving first preference to consumables in accordance with AWS 307 and second preference to those in accordance with AWS 309. These types of consumables have yield strengths up to approximately 500 MPa

in all the weld metal. The AWS 307 type can withstand hot cracking better than AWS 309. It should be noted that manufacturers seldom specify the hydrogen content of stainless steel consumables, since hydrogen does not affect the performance as much as it does in unalloyed and low-alloyed consumables. Suggestions for various stainless steel consumables are given at www.ssab.com in the publication TechSupport #60.

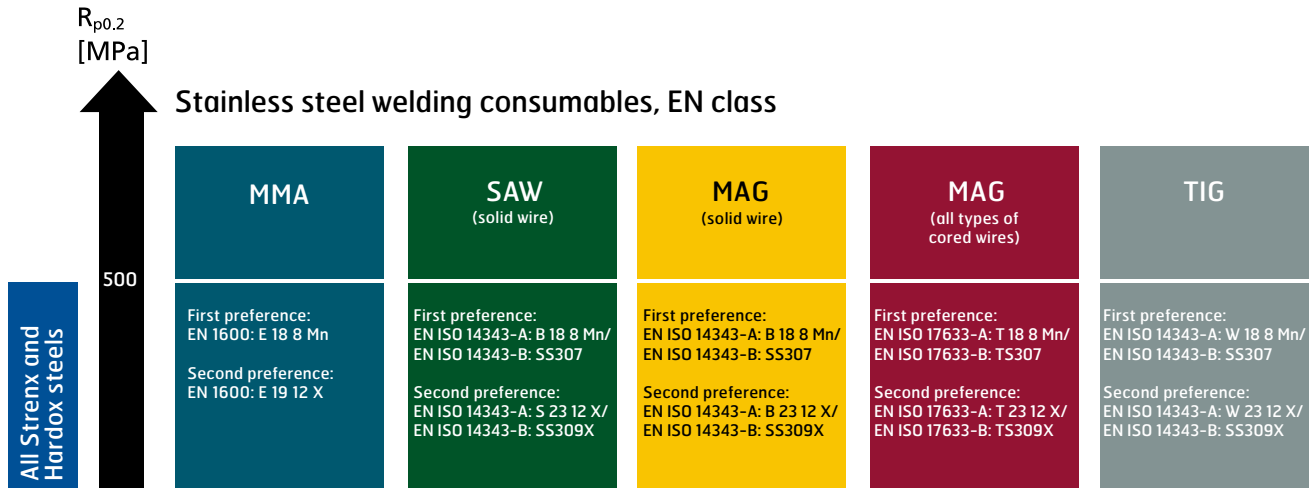

Note that X may stand for one or several characters.

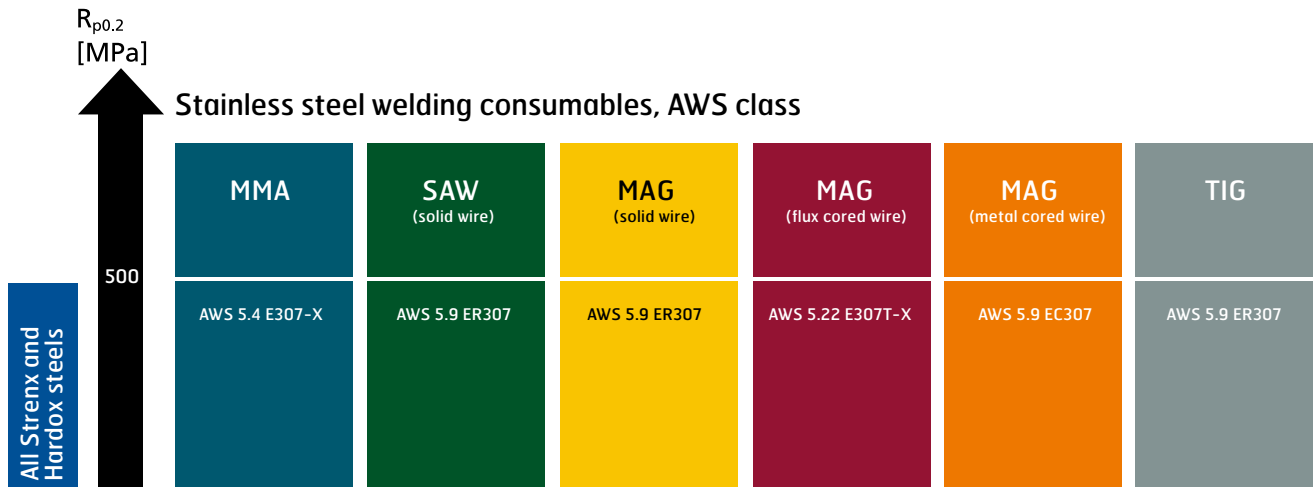

Note that X stands for one or several characters.

Hard facings

Hard facing with special consumables increases the wear resistance of welded joints. Both the instructions for the consumables used and the ordinary recommendations for Strenx and Hardox should be followed.

It is beneficial to weld a buffer layer with extra high toughness between the ordinary welded joint or plate and the hard facing. The choice of consumables for the buffer layer should follow the welding recommendations for Strenx and Hardox steels. Stainless steel consumables

in accordance with AWS 307 and AWS 309 should preferably be used for the buffer layer.

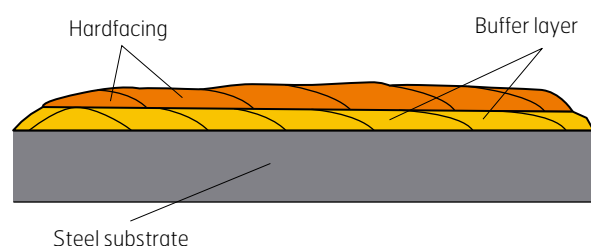

Shielding gas

The choice and mixture of shielding gases is dependent on the welding situation and Ar and CO₂ are the most commonly used.

EFFECTS OF VARIOUS SHIELDING GAS MIXTURES

- ▶ Facilitates striking of the arc
- ▶ Reduced spatter
- ▶ Low amount of oxides

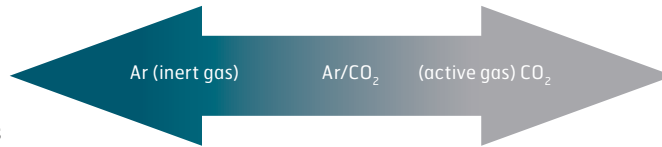

- ▶ Stable arc
- ▶ Low porosity
- ▶ More weld spatter/clogging of the welding nozzle
- ▶ High penetration of the weld metal

EXAMPLES OF SHIELDING GAS MIXTURES ARE GIVEN BELOW.

Welding method	Arc type	Shielding gas (volume %)
MAG, solid wire MAG, metal cored wire	Short arc	Ar + 15-25 % CO ₂
MAG, solid wire MAG, metal cored wire	Spray arc	Ar + 8-25 % CO ₂
MAG, flux cored wire	Short arc	Ar + 15-25 % CO ₂ , or pure CO ₂
MAG, flux cored wire	Spray arc	Ar + 8-25 % CO ₂
MAG, all types	All arc types	Ar + 15-25 CO ₂
TIG		Pure Ar

In all welding methods based on shielding gas, the flow of shielding gas is dependent on the welding situation. A general guideline is that the shielding gas flow in l / min should be set to the same value as the inside diameter of the nozzle measured in mm.

Weld sequences and gap size

TO AVOID HYDROGEN CRACKS IN THE WELDED JOINT:

- ▶ The starting and stopping sequences should not be located in a corner. If possible, the starting and stopping procedures should be at least 5–10 cm from a corner.
- ▶ The gap in the weld joint should be a maximum of 3 mm.

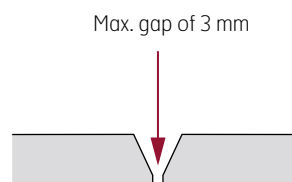
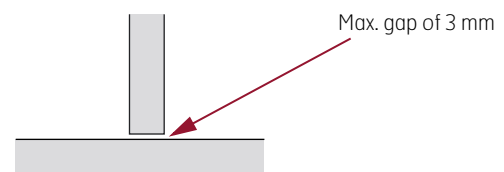
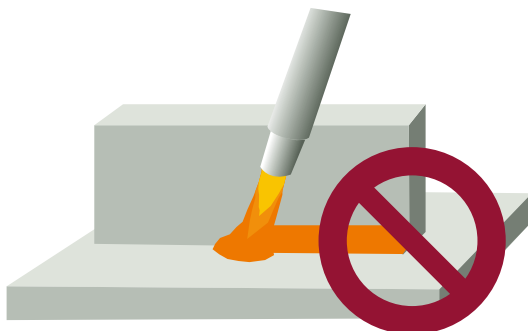

Welding on the Strenx and Hardox primer



For best possible results, the primer can be removed.

Welding can be carried out directly on the excellent Strenx and Hardox primer, due to its low zinc content.

The primer can easily be brushed or ground away in the area around the joint. Removing the primer prior to welding can be beneficial, as it can minimize the porosity in the weld and can facilitate welding in positions other than the horizontal.

If the primer is left on the weld preparation, the porosity of the weld metal will be slightly increased. The MAG welding process with flux cored wire and the MMA welding process offer the lowest porosity.

As in all welding operations good ventilation must be maintained, then the primer will not have a harmful effect on the welder and his surroundings.

Post weld heat treatment

Strenx 700–960 and Hardox HiTuf can be stress relieved by post weld heat treatment, although this is seldom necessary. Other Strenx and Hardox steels should not use this method for stress relieving, since this may impair the mechanical properties.

For further information, see the Welding Handbook from SSAB. This can be ordered at www.ssab.com.

SSAB is a Nordic and US-based steel company. SSAB offers value added products and services developed in close cooperation with its customers to create a stronger, lighter and more sustainable world. SSAB has employees in over 50 countries. SSAB has production facilities in Sweden, Finland and the US. SSAB is listed on the NASDAQ OMX Nordic Exchange in Stockholm and has a secondary listing on the NASDAQ OMX in Helsinki. www.ssab.com

SSAB
SE-613 80 Oxelösund
Sweden

T+46 155 25 40 00
F+46 155 25 40 73
Econtact@ssab.com

www.ssab.com

SSAB